

FEATURES

Bandwidth: 50 MHz @ 5 V
Low Noise: 4.5 nV/ $\sqrt{\text{Hz}}$
Offset voltage: 100 μV typ, specified over entire common-mode range
41 V/ μs slew rate
Rail-to-rail input and output swing
Input bias current: 1 pA
Single-supply operation: 2.7 V to 5.5 V
Space-saving MSOP and SOIC packaging

APPLICATIONS

Optical communications
Laser source drivers/controllers
Broadband communications
High speed ADC and DAC
Microwave link interface
Cell phone PA control
Video line driver
Audio

GENERAL DESCRIPTION

The AD8651 is a high precision, low noise, low distortion, rail-to-rail CMOS operational amplifier that runs from a single-supply voltage of 2.7 V to 5 V.

The AD8651 is a rail-to-rail input and output amplifier with a gain bandwidth of 50 MHz and a typical voltage offset of 100 μV across common mode from a 5 V supply. It also features low noise—4.5 nV/ $\sqrt{\text{Hz}}$.

The AD8651 can be used in communications applications, such as cell phone transmission power control, fiber optic networking, wireless networking, and video line drivers.

PIN CONFIGURATIONS

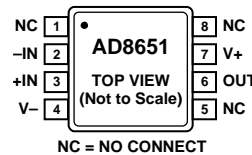

Figure 1. 8-Lead MSOP (RM-8)

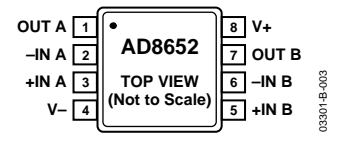

Figure 2. 8-Lead MSOP (RM-8)

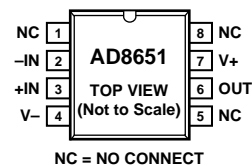

Figure 3. 8-Lead SOIC (R-8)

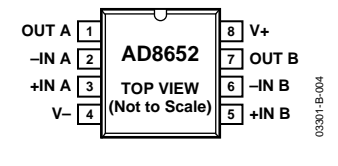

Figure 4. 8-Lead SOIC (R-8)

The AD8651 features the newest generation of DigiTrim® in-package trimming. This new generation measures and corrects the offset over the entire input common-mode range, providing less distortion from V_{OS} variation than is typical of other rail-to-rail amplifiers. Offset voltage and CMRR are both specified and guaranteed over the entire common-mode range as well as over the extended industrial temperature range.

The AD8651 is offered in the 8-lead SOIC package and the 8-lead MSOP package. It is specified over the extended industrial temperature range (-40°C to $+125^{\circ}\text{C}$).

Rev. B

Information furnished by Analog Devices is believed to be accurate and reliable. However, no responsibility is assumed by Analog Devices for its use, nor for any infringements of patents or other rights of third parties that may result from its use. Specifications subject to change without notice. No license is granted by implication or otherwise under any patent or patent rights of Analog Devices. Trademarks and registered trademarks are the property of their respective owners.

TABLE OF CONTENTS

Electrical Characteristics	3	Layout, Grounding, and Bypassing considerations	15
Electrical Characteristics	4	Power Supply Bypassing	15
Absolute Maximum Ratings.....	5	Grounding.....	15
ESD Caution.....	5	Leakage Currents.....	15
Typical Performance Characteristics	6	Input Capacitance	15
Applications.....	14	Output Capacitance	16
Theory of Operation	14	Settling Time.....	16
Rail-to-Rail Output Stage.....	14	THD Readings vs. Common-Mode Voltage	16
Rail-to-Rail Input Stage.....	14	Driving a 16-Bit ADC.....	17
Input Protection	15	Outline Dimensions	18
Overdrive Recovery	15	Ordering Guide	18

REVISION HISTORY

9/04—Data Sheet Changed from Rev. A to Rev. B

Added AD8652	Universal
Change to General Description	1
Changes to Electrical Characteristics	3
Changes to Absolute Maximum Ratings	5
Change to Figure 23	9
Change to Figure 26	9
Change to Figure 36	11
Change to Figure 42	12
Change to Figure 49	13
Change to Figure 51	13
Inserted Figure 52.....	13
Change to Theory of Operation section.....	14
Change to Input Protection section	15
Changes to Ordering Guide	20

6/04—Changed from REV. 0 to REV. A

Change to Figure 18	8
Change to Figure 21	9
Change to Figure 29	10
Change to Figure 30	10
Change to Figure 43	12
Change to Figure 44	12
Change to Figure 47	13
Change to Figure 57	17

10/03 Revision 0: Initial Version

ELECTRICAL CHARACTERISTICS

Table 1. $V_+ = 2.7\text{ V}$, $V_- = 0\text{ V}$, $V_{CM} = V_+/2$, $T_A = 25^\circ\text{C}$, unless otherwise specified

Parameter	Symbol	Conditions	Min	Typ	Max	Unit
INPUT CHARACTERISTICS						
Offset Voltage	V_{OS}	$0 \leq V_{CM} \leq 2.7\text{ V}$		100	350	μV
AD8651		$-40^\circ\text{C} \leq T_A \leq +85^\circ\text{C}$, $0 \leq V_{CM} \leq 2.7\text{ V}$			1.4	mV
		$-40^\circ\text{C} \leq T_A \leq +125^\circ\text{C}$, $0 \leq V_{CM} \leq 2.7\text{ V}$			1.6	mV
AD8652		$0 \leq V_{CM} \leq 2.7\text{ V}$		90	300	μV
		$-40^\circ\text{C} \leq T_A \leq +125^\circ\text{C}$, $0 \leq V_{CM} \leq 2.7\text{ V}$		0.4	1.3	mV
Offset Voltage Drift					4	
Input Bias Current	I_B			1	10	pA
		$-40^\circ\text{C} \leq T_A \leq +125^\circ\text{C}$				600
Input Offset Current	I_{OS}			1	10	pA
		$-40^\circ\text{C} \leq T_A \leq +85^\circ\text{C}$				30
		$-40^\circ\text{C} \leq T_A \leq +125^\circ\text{C}$			600	pA
Input Voltage Range		V_{CM}		-0.1		+2.8
Common-Mode Rejection Ratio	CMRR	$V_+ = 2.7\text{ V}$, $-0.1\text{ V} < V_{CM} < +2.8\text{ V}$	75	95		dB
AD8651		$-40^\circ\text{C} \leq T_A \leq +85^\circ\text{C}$, $-0.1\text{ V} < V_{CM} < +2.8\text{ V}$	70	88		dB
		$-40^\circ\text{C} \leq T_A \leq +125^\circ\text{C}$, $-0.1\text{ V} < V_{CM} < +2.8\text{ V}$	65	85		dB
AD8652		$V_+ = 2.7\text{ V}$, $-0.1\text{ V} < V_{CM} < +2.8\text{ V}$	77	95		dB
		$-40^\circ\text{C} \leq T_A \leq +125^\circ\text{C}$, $-0.1\text{ V} < V_{CM} < +2.8\text{ V}$	73	90		dB
Large Signal Voltage Gain		A_{VO}	$R_L = 1\text{ k}\Omega$, $200\text{ mV} < V_O < 2.5\text{ V}$	100	115	
	$R_L = 1\text{ k}\Omega$, $200\text{ mV} < V_O < 2.5\text{ V}$, $T_A = +85^\circ\text{C}$		100	114		dB
	$R_L = 1\text{ k}\Omega$, $200\text{ mV} < V_O < 2.5\text{ V}$, $T_A = +125^\circ\text{C}$		95	108		dB
OUTPUT CHARACTERISTICS						
Output Voltage High	V_{OH}	$I_L = 250\text{ }\mu\text{A}$, $-40^\circ\text{C} \leq T_A \leq +125^\circ\text{C}$	2.67			V
Output Voltage Low	V_{OL}	$I_L = 250\text{ }\mu\text{A}$, $-40^\circ\text{C} \leq T_A \leq +125^\circ\text{C}$			30	mV
Short Circuit Limit	I_{SC}	Sourcing		80		mA
		Sinking			80	
Output Current	I_O			+40		mA
POWER SUPPLY						
Power Supply Rejection Ratio	PSRR	$V_S = 2.7\text{ V}$ to 5.5 V , $V_{CM} = 0\text{ V}$	76	94		dB
		$-40^\circ\text{C} \leq T_A \leq +125^\circ\text{C}$	74	93		dB
Supply Current	I_{SY}	$I_O = 0$		9	12	mA
AD8651		$-40^\circ\text{C} \leq T_A \leq +125^\circ\text{C}$				14.5
		$I_O = 0$		17.5	19.5	mA
AD8652		$-40^\circ\text{C} \leq T_A \leq +125^\circ\text{C}$				22.5
INPUT CAPACITANCE						
Differential	C_{IN}			6		pF
Common-Mode					9	
DYNAMIC PERFORMANCE						
Slew Rate	SR	$G = 1$, $R_L = 10\text{ k}\Omega$		41		$\text{V}/\mu\text{s}$
Gain Bandwidth Product	GBP	$G = 1$		50		MHz
Settling Time, 0.01%		$G = \pm 1$, 2 V Step			0.2	
Overload Recovery Time		$V_{IN} \times G = 1.48\text{ V}_+$		0.1		μs
Total Harmonic Distortion + Noise	THD + N	$G = 1$, $R_L = 600\text{ }\Omega$, $f = 1\text{ kHz}$, $V_{IN} = 2\text{ V p-p}$		0.0006		%
NOISE PERFORMANCE						
Voltage Noise Density	e_n	$f = 10\text{ kHz}$		5		$\text{nV}/\sqrt{\text{Hz}}$
		$f = 100\text{ kHz}$			4.5	
Current Noise Density	i_n	$f = 10\text{ kHz}$		4		$\text{fA}/\sqrt{\text{Hz}}$

AD8651/AD8652

ELECTRICAL CHARACTERISTICS

Table 2. $V_+ = 5\text{ V}$, $V_- = 0\text{ V}$, $V_{CM} = V_+/2$, $T_A = 25^\circ\text{C}$, unless otherwise specified

Parameter	Symbol	Conditions	Min	Typ	Max	Unit
INPUT CHARACTERISTICS						
Offset Voltage	V_{OS}	$0 \leq V_{CM} \leq 5\text{ V}$ $-40^\circ\text{C} \leq T_A \leq +85^\circ\text{C}$, $0 \leq V_{CM} \leq 5\text{ V}$ $-40^\circ\text{C} \leq T_A \leq +125^\circ\text{C}$, $0 \leq V_{CM} \leq 5\text{ V}$		100	350	μV
AD8651				1.4		mV
		$0 \leq V_{CM} \leq 5\text{ V}$ $-40^\circ\text{C} \leq T_A \leq +125^\circ\text{C}$, $0 \leq V_{CM} \leq 5\text{ V}$		90	300	μV
AD8652				0.4	1.4	mV
Offset Voltage Drift				4		$\mu\text{V}/^\circ\text{C}$
Input Bias Current	I_B	$-40^\circ\text{C} \leq T_A \leq +85^\circ\text{C}$ $-40^\circ\text{C} \leq T_A \leq +125^\circ\text{C}$		1	10	pA
				30		pA
					600	pA
Input Offset Current	I_{OS}	$-40^\circ\text{C} \leq T_A \leq +85^\circ\text{C}$ $-40^\circ\text{C} \leq T_A \leq +125^\circ\text{C}$		1	10	pA
				30		pA
					600	pA
Input Voltage Range	V_{CM}		-0.1		+5.1	V
Common-Mode Rejection Ratio	CMRR	$0.1\text{ V} < V_{CM} < 5.1\text{ V}$ $-40^\circ\text{C} \leq T_A \leq +85^\circ\text{C}$, $0.1\text{ V} < V_{CM} < 5.1\text{ V}$ $-40^\circ\text{C} \leq T_A \leq +125^\circ\text{C}$, $0.1\text{ V} < V_{CM} < 5.1\text{ V}$		80	95	dB
AD8651				75	94	dB
				70	90	dB
AD8652				84	100	dB
				76	95	dB
Large Signal Voltage Gain	A_{VO}	$R_L = 1\text{ k}\Omega$, $200\text{ mV} < V_O < 4.8\text{ V}$ $R_L = 1\text{ k}\Omega$, $200\text{ mV} < V_O < 4.8\text{ V}$, $T_A = +85^\circ\text{C}$ $R_L = 1\text{ k}\Omega$, $200\text{ mV} < V_O < 4.8\text{ V}$, $T_A = +125^\circ\text{C}$		100	115	dB
				98	114	dB
				95	111	dB
OUTPUT CHARACTERISTICS						
Output Voltage High	V_{OH}	$I_L = 250\ \mu\text{A}$, $-40^\circ\text{C} \leq T_A \leq +125^\circ\text{C}$		4.97		V
Output Voltage Low	V_{OL}	$I_L = 250\ \mu\text{A}$, $-40^\circ\text{C} \leq T_A \leq +125^\circ\text{C}$			30	mV
Short Circuit Limit	I_{SC}	Sourcing		80		mA
		Sinking		80		mA
Output Current	I_O			+40		mA
POWER SUPPLY						
Power Supply Rejection Ratio	PSRR	$V_S = 2.7\text{ V}$ to 5.5 V , $V_{CM} = 0\text{ V}$ $-40^\circ\text{C} \leq T_A \leq +125^\circ\text{C}$		76	94	dB
				74	93	dB
Supply Current	I_{SY}	$I_O = 0$ $-40^\circ\text{C} \leq T_A \leq +125^\circ\text{C}$		9.5	14.0	mA
AD8651				15		mA
		$I_O = 0$ $-40^\circ\text{C} \leq T_A \leq +125^\circ\text{C}$		17.5	20.0	mA
AD8652				23.5		mA
INPUT CAPACITANCE						
Differential	C_{IN}			6		pF
Common-Mode				9		pF
DYNAMIC PERFORMANCE						
Slew Rate	SR	$G = 1$, $R_L = 10\text{ k}\Omega$		41		$\text{V}/\mu\text{s}$
Gain Bandwidth Product	GBP	$G = 1$ $G = \pm 1$, 2 V Step		50		MHz
Settling Time, 0.01%				0.2		μs
Overload Recovery Time		$V_{IN} \times G = 1.2\text{ V}_+$		0.1		μs
Total Harmonic Distortion + Noise	THD + N	$G = 1$, $R_L = 600\ \Omega$, $f = 1\text{ kHz}$, $V_{IN} = 2\text{ V p-p}$		0.0006		%
NOISE PERFORMANCE						
Voltage Noise Density	e_n	$f = 10\text{ kHz}$ $f = 100\text{ kHz}$		5		$\text{nV}/\sqrt{\text{Hz}}$
				4.5		$\text{nV}/\sqrt{\text{Hz}}$
Current Noise Density	I_n	$f = 10\text{ kHz}$		4		$\text{fA}/\sqrt{\text{Hz}}$

ABSOLUTE MAXIMUM RATINGS

Absolute maximum ratings apply at 25°C, unless otherwise noted.

Table 3.

Parameter	Rating
Supply Voltage	6.0 V
Input Voltage	GND to $V_S + 0.3$ V
Differential Input Voltage	± 6.0 V
Output Short-Circuit Duration to GND	Indefinite
Electrostatic Discharge (HBM)	4000 V
Storage Temperature Range	
RM, R Package	–65°C to +150°C
Operating Temperature Range	–40°C to +125°C
Junction Temperature Range	
RM, R Package	–65°C to +150°C
Lead Temperature (Soldering, 10 s)	300°C

Table 4.

Package Type	θ_{JA}^1	θ_{JC}	Unit
8-Lead MSOP (RM)	210	45	°C/W
8-Lead SOIC (R)	158	43	°C/W

¹ θ_{JA} is specified for the worst-case conditions, i.e., θ_{JA} is specified for device soldered in circuit board for surface-mount packages.

Stresses above those listed under Absolute Maximum Ratings may cause permanent damage to the device. This is a stress rating only; functional operation of the device at these or any other conditions above those indicated in the operational section of this specification is not implied. Exposure to absolute maximum rating conditions for extended periods may affect device reliability.

ESD CAUTION

ESD (electrostatic discharge) sensitive device. Electrostatic charges as high as 4000 V readily accumulate on the human body and test equipment and can discharge without detection. Although this product features proprietary ESD protection circuitry, permanent damage may occur on devices subjected to high energy electrostatic discharges. Therefore, proper ESD precautions are recommended to avoid performance degradation or loss of functionality.



TYPICAL PERFORMANCE CHARACTERISTICS

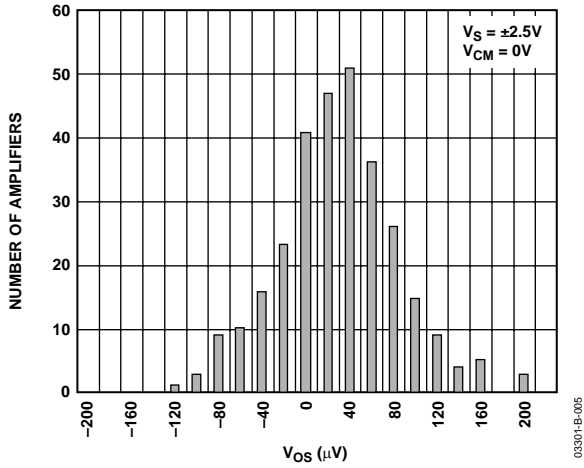

Figure 5. Input Offset Voltage Distribution

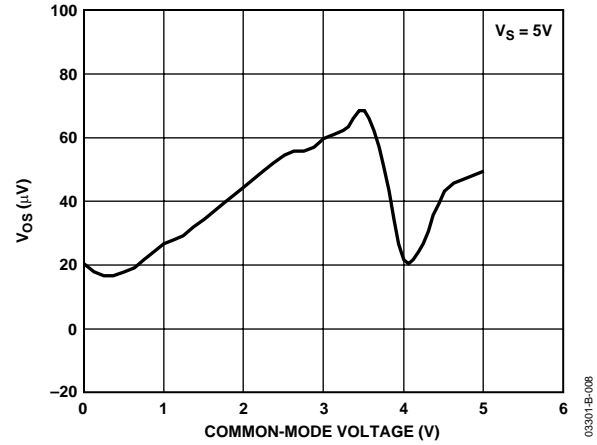

Figure 8. Input Offset Voltage vs. Common-Mode Voltage

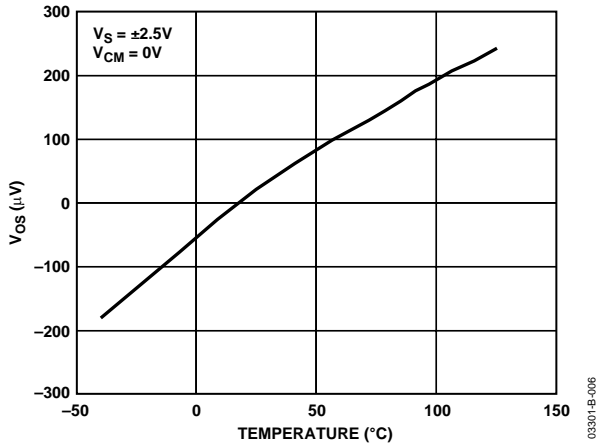

Figure 6. Input Offset Voltage vs. Temperature

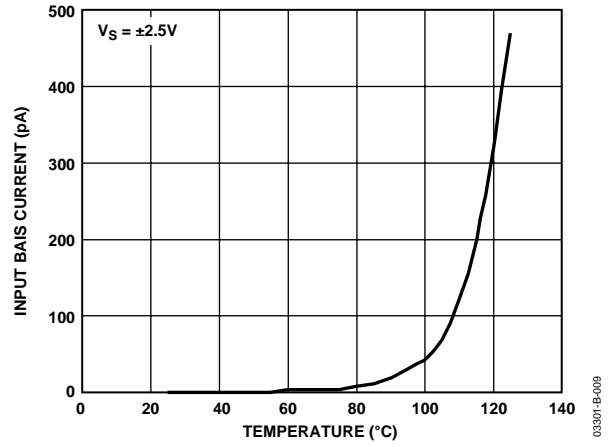

Figure 9. Input Bias Current vs. Temperature

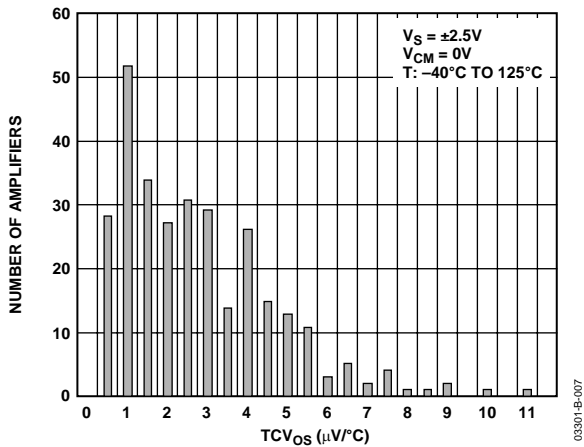

Figure 7. TCV_{OS} Distribution

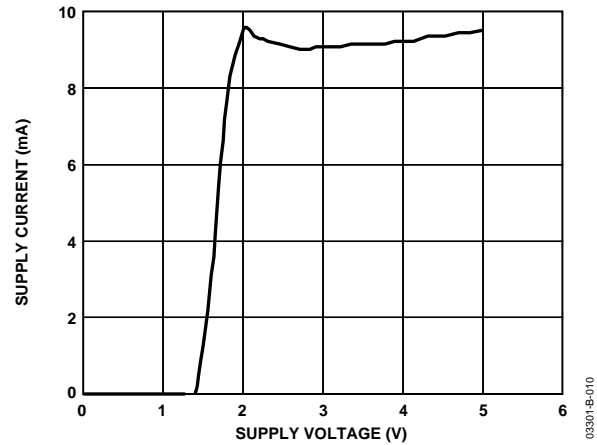

Figure 10. Supply Current vs. Supply Voltage

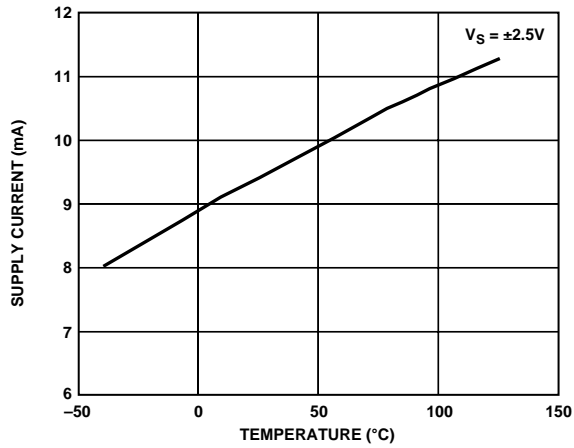

Figure 11. Supply Current vs. Temperature

03301-B-011

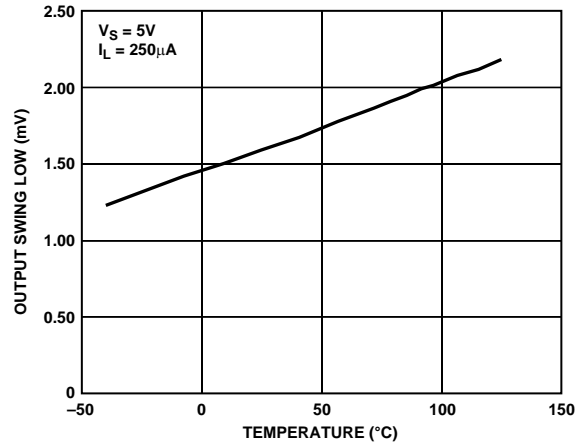

Figure 14. Output Voltage Swing Low vs. Temperature

03301-B-014

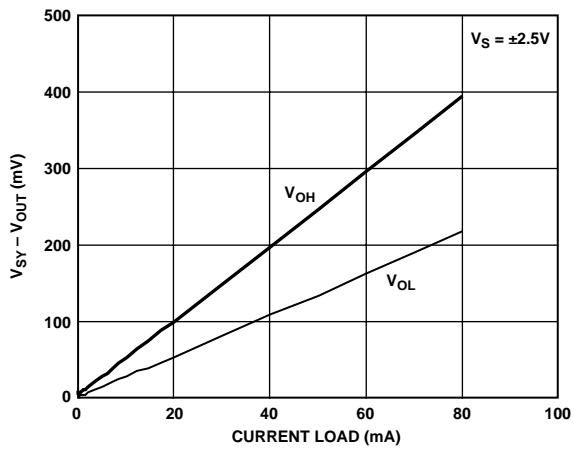

Figure 12. Output Voltage to Supply Rail vs. Load Current

03301-B-012

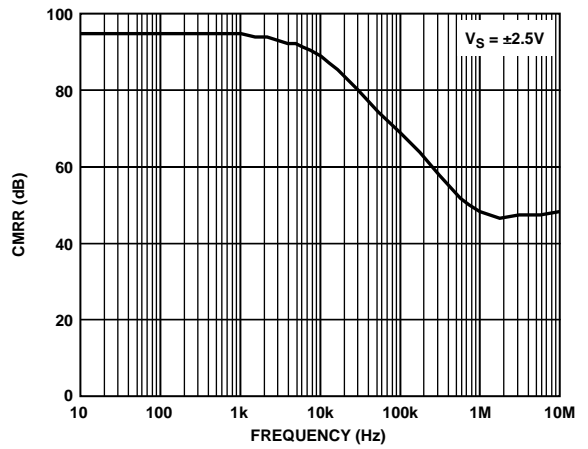

Figure 15. CMRR vs. Frequency

03301-B-015

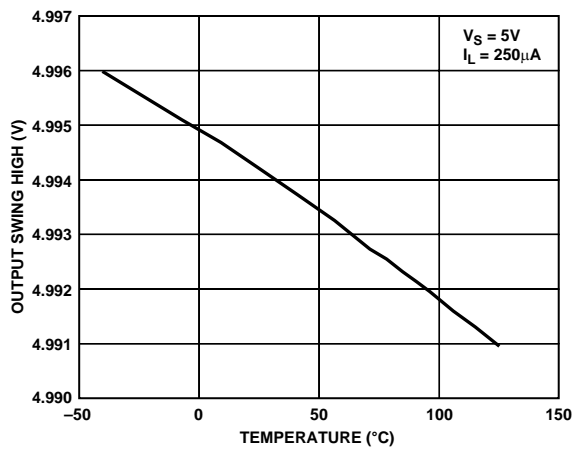

Figure 13. Output Voltage Swing High vs. Temperature

03301-B-013

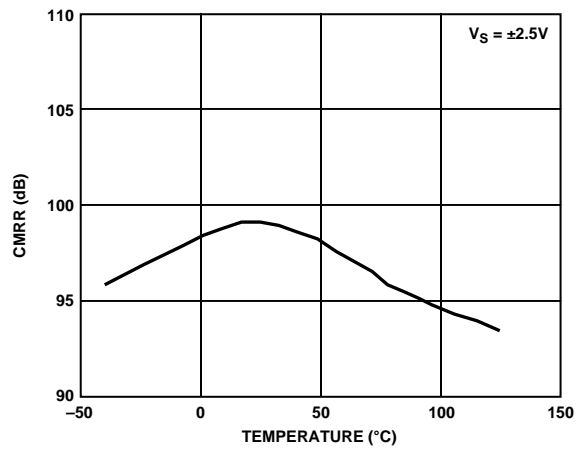

Figure 16. CMRR vs. Temperature

03301-B-016

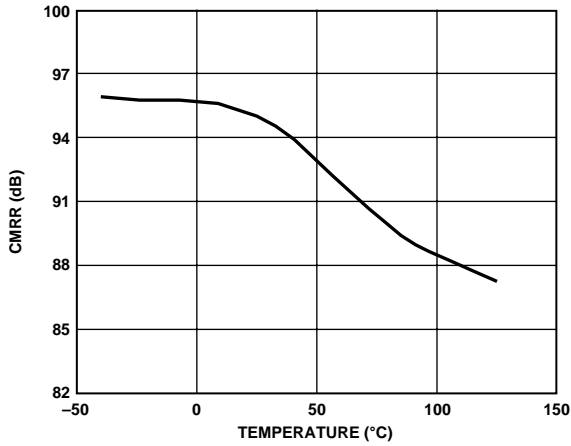

Figure 17. CMRR vs. Temperature

03301-B-017

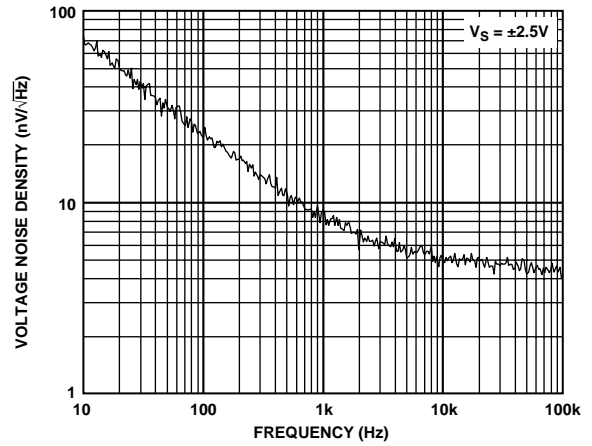

Figure 20. Voltage Noise Density vs. Frequency

03301-B-020

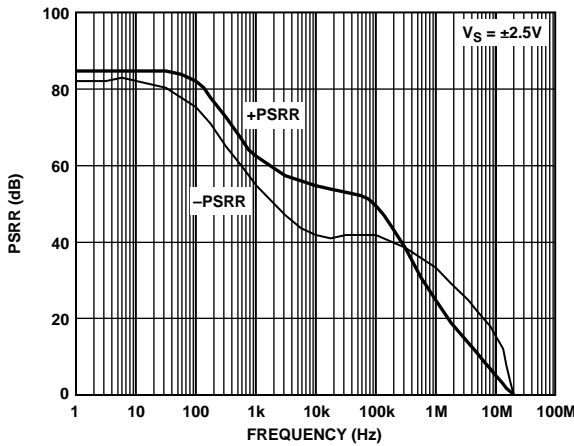

Figure 18. PSRR vs. Frequency

03301-B-018

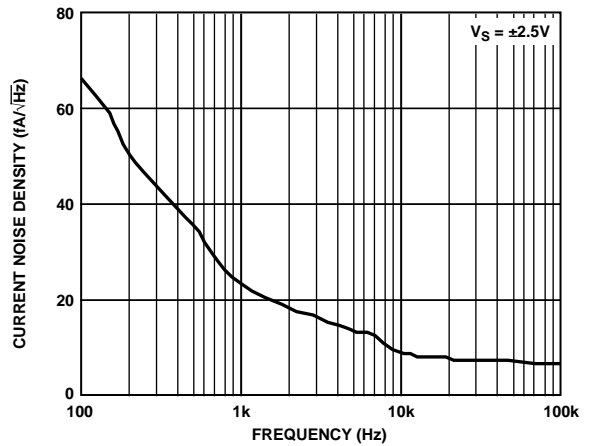

Figure 21. Current Noise Density vs. Frequency

03301-B-021

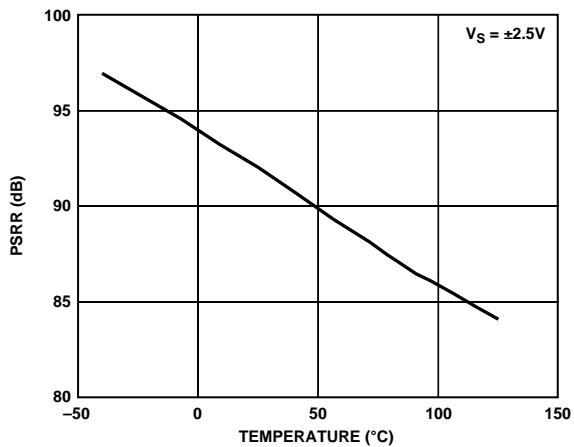

Figure 19. PSRR vs. Temperature

03301-B-019

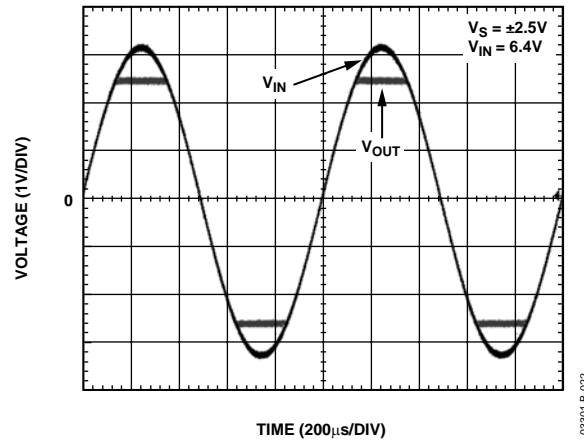

Figure 22. No Phase Reversal

03301-B-022

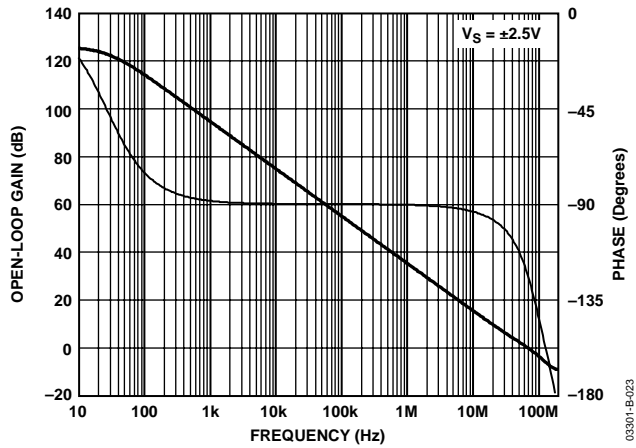

Figure 23. Open-Loop Gain and Phase vs. Frequency

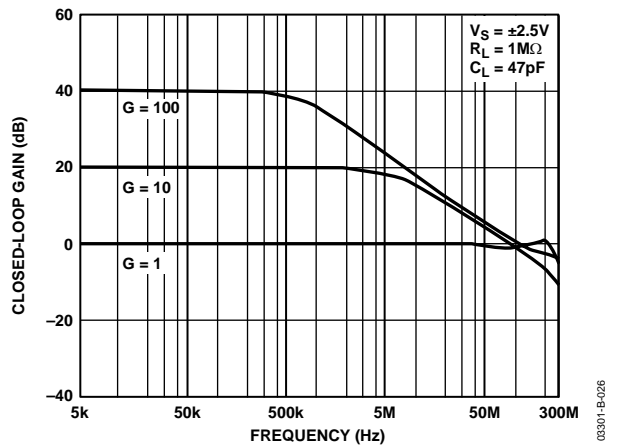

Figure 26. Closed-Loop Gain vs. Frequency

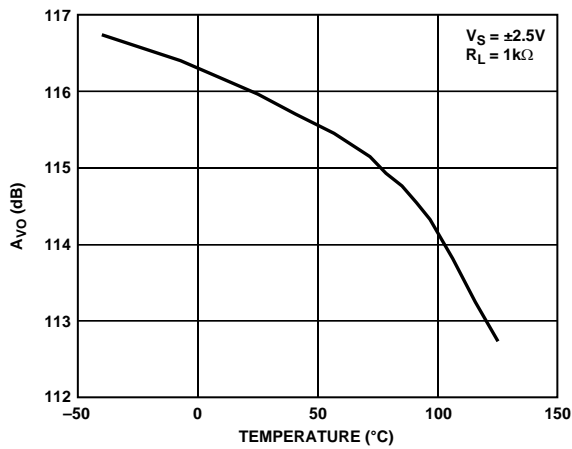

Figure 24. Open-Loop Gain vs. Temperature

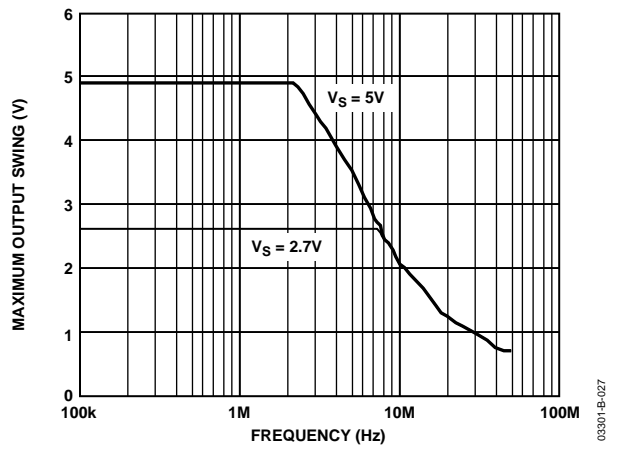

Figure 27. Maximum Output Swing vs. Frequency

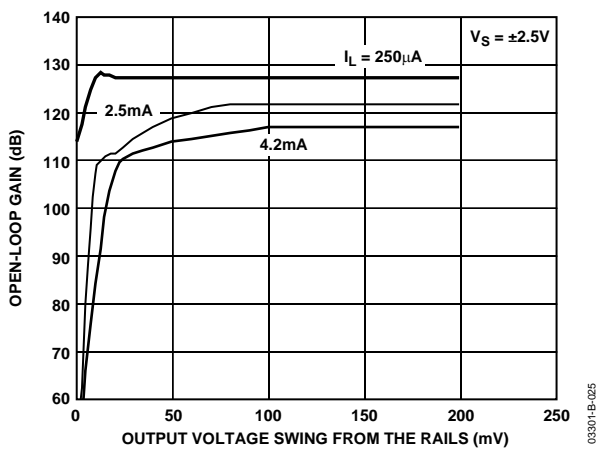

Figure 25. Open-Loop Gain vs. Output Voltage Swing

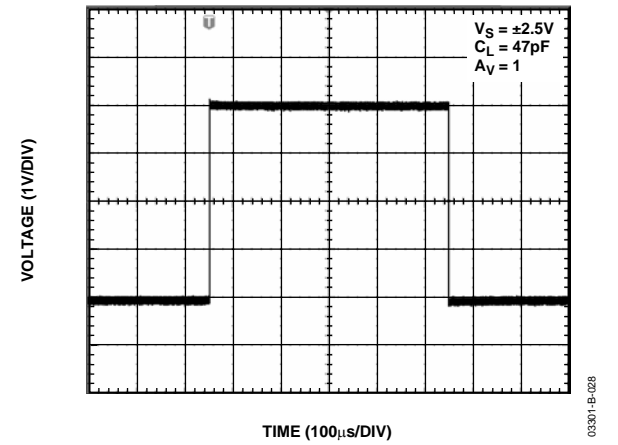

Figure 28. Large Signal Response

AD8651/AD8652

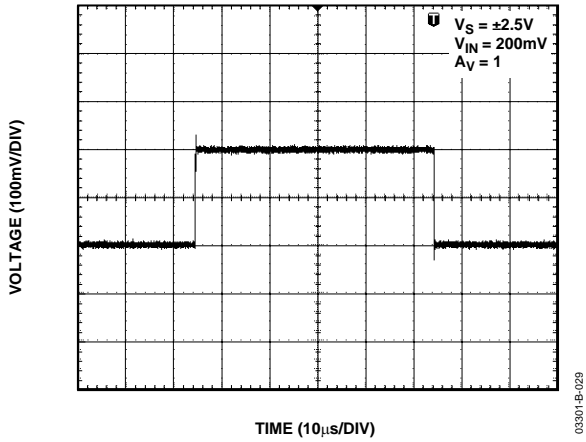

Figure 29. Small Signal Response

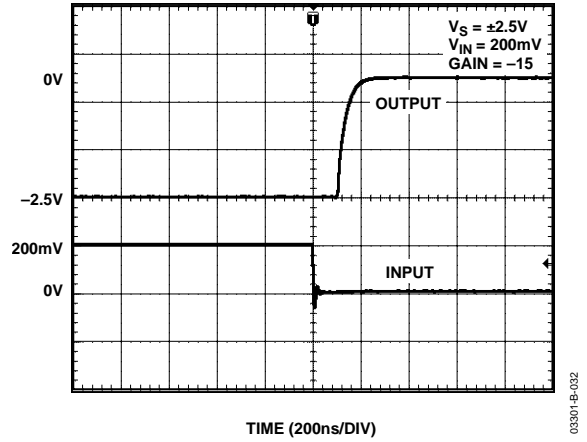

Figure 32. Positive Overload Recovery Time

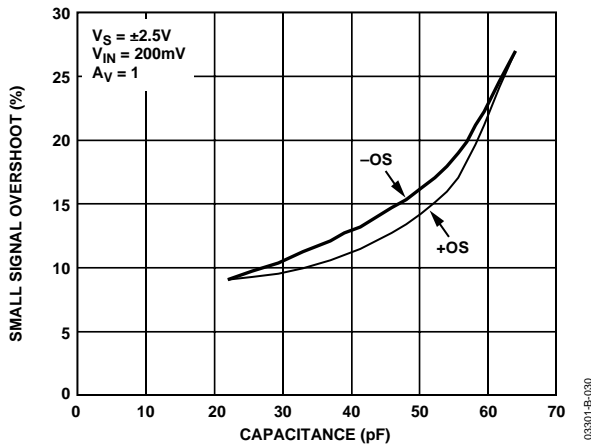

Figure 30. Small Signal Overshoot vs. Load Capacitance

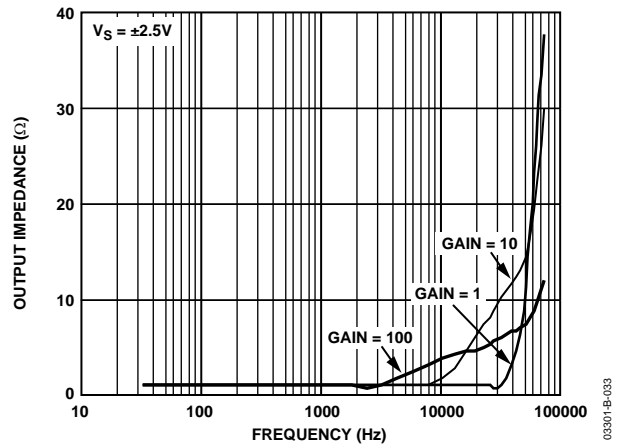

Figure 33. Output Impedance vs. Frequency

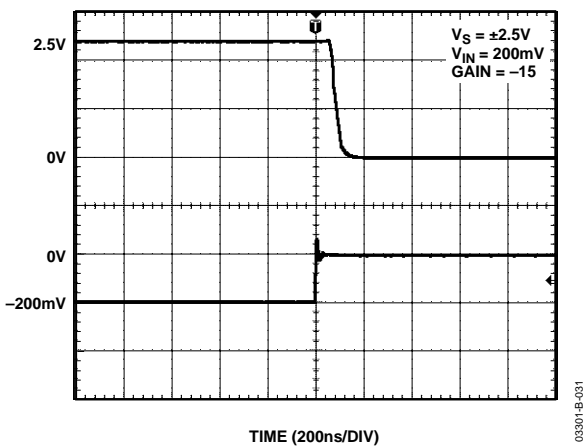

Figure 31. Negative Overload Recovery Time

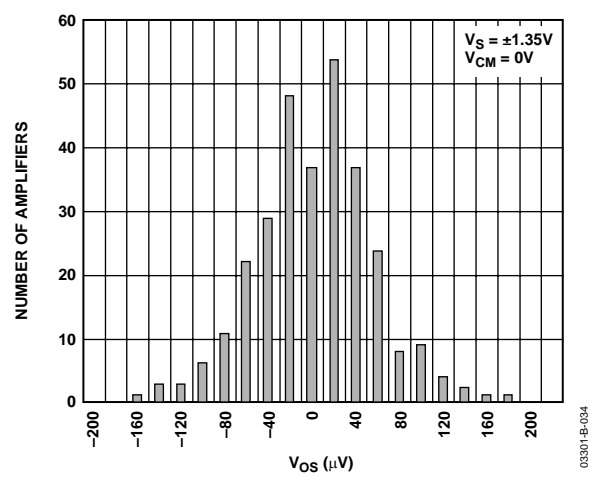

Figure 34. Input Offset Voltage Distribution

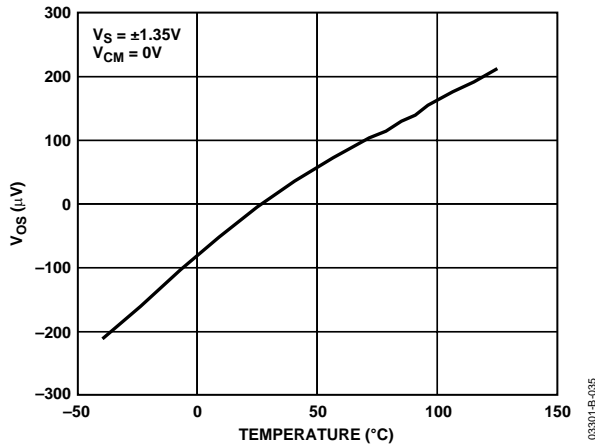

Figure 35. Input Offset Voltage vs. Temperature

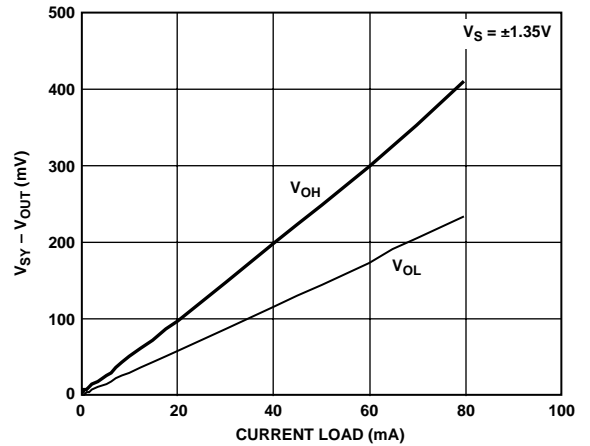

Figure 38. Output Voltage to Supply Rail vs. Load Current

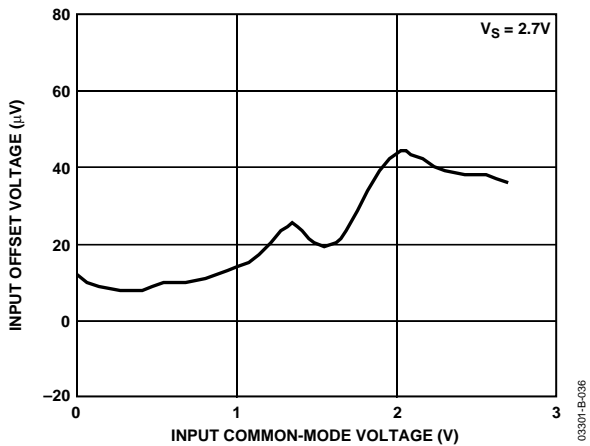

Figure 36. Input Offset Voltage vs. Common-Mode Voltage

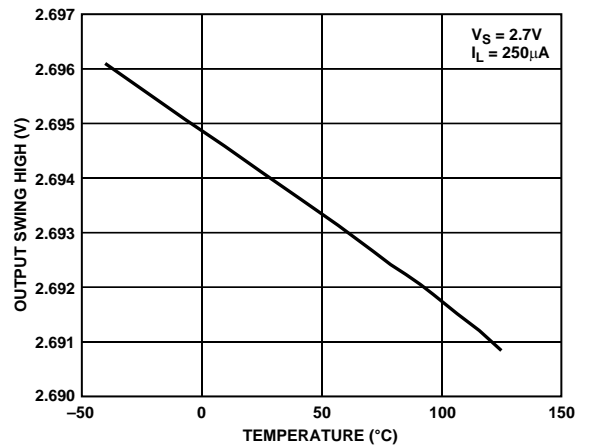

Figure 39. Output Voltage Swing High vs. Temperature

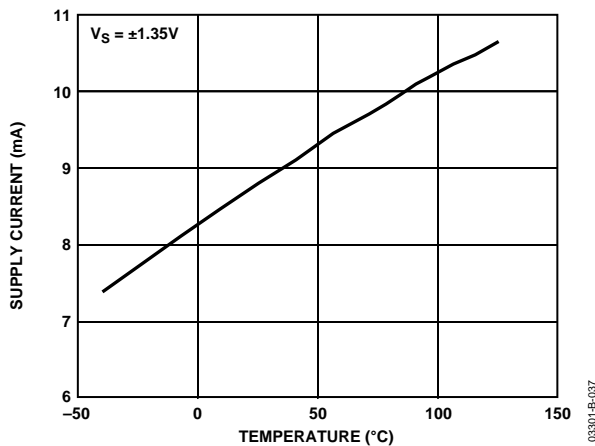

Figure 37. Supply Current vs. Temperature

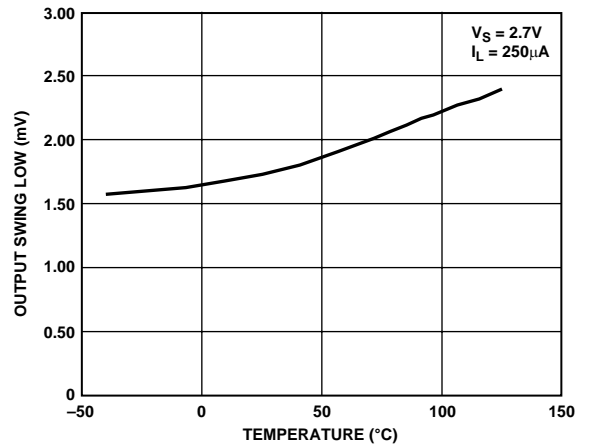

Figure 40. Output Voltage Swing Low vs. Temperature

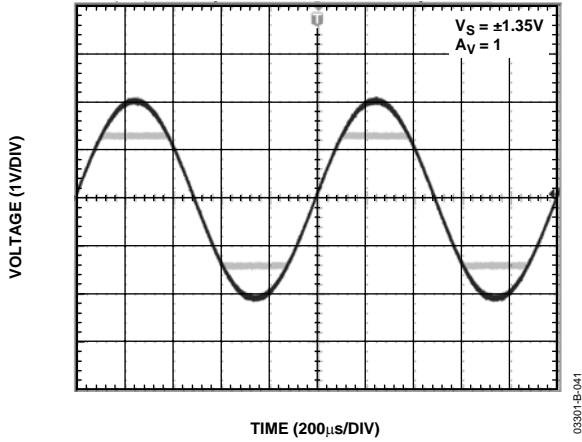

Figure 41. No Phase Reversal

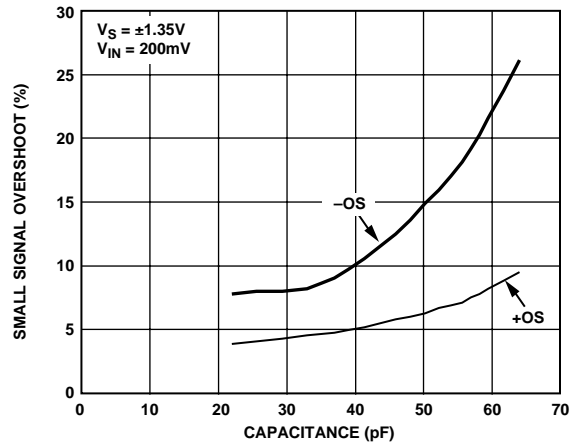

Figure 44. Small Signal Overshoot vs. Load Capacitance

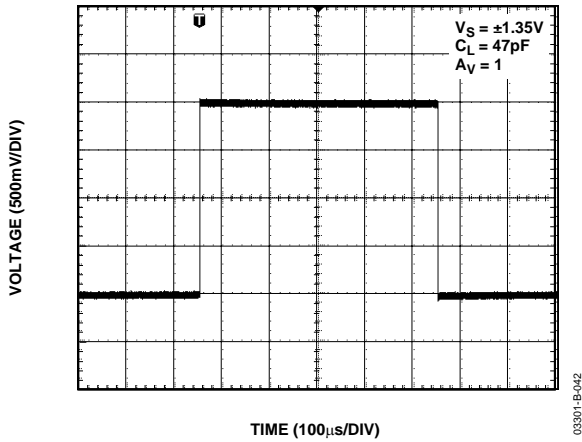

Figure 42. Large Signal Response

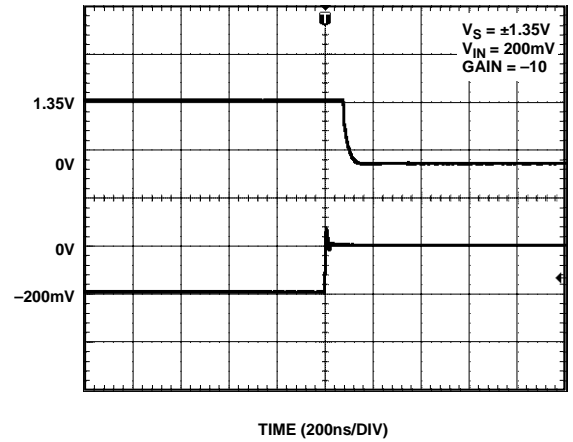

Figure 45. Negative Overload Recovery Time

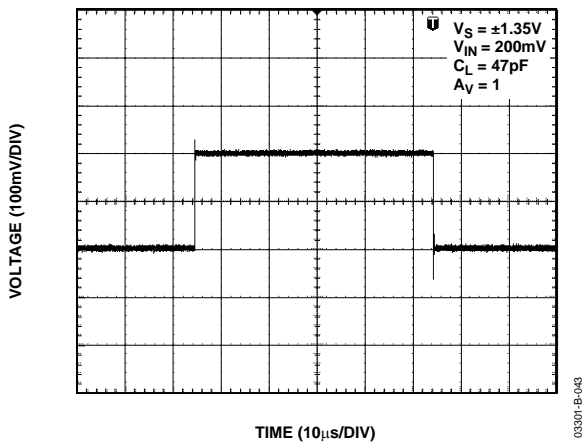

Figure 43. Small Signal Response

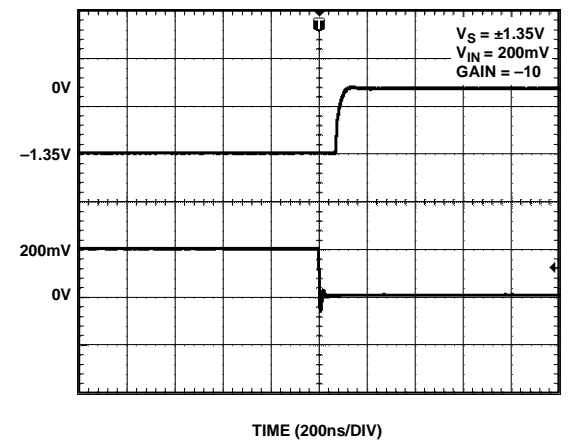

Figure 46. Positive Overload Recovery Time

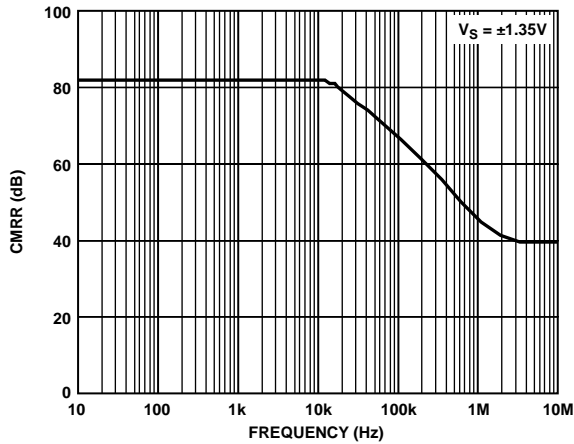

Figure 47. CMRR vs. Frequency

03301-B-047

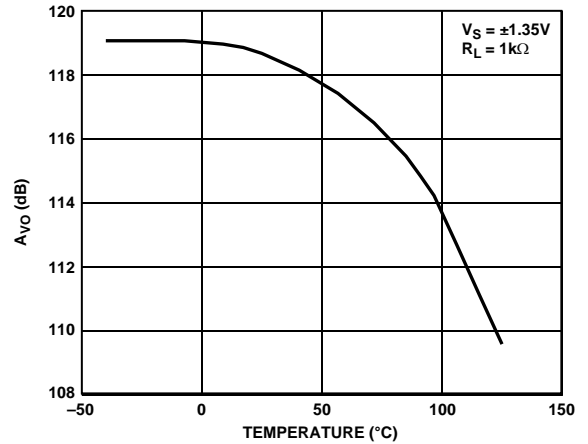

Figure 50. Open-Loop Gain vs. Temperature

03301-B-051

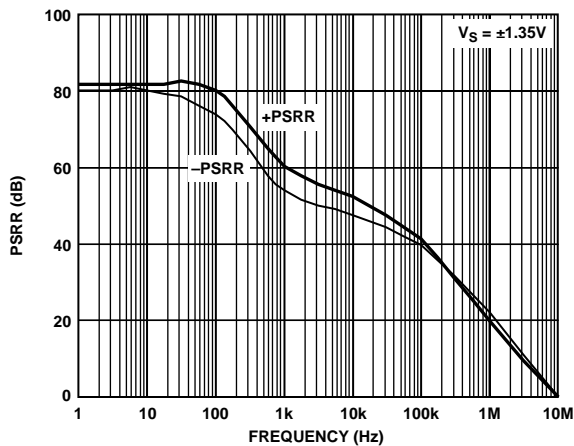

Figure 48. PSRR vs. Frequency

03301-B-048

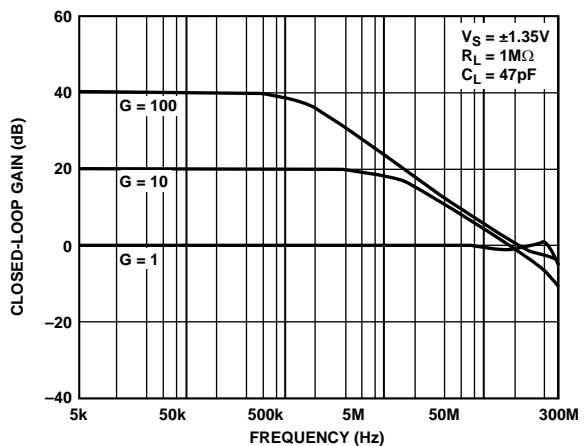

Figure 51. Closed-Loop Gain vs. Frequency

03301-B-052

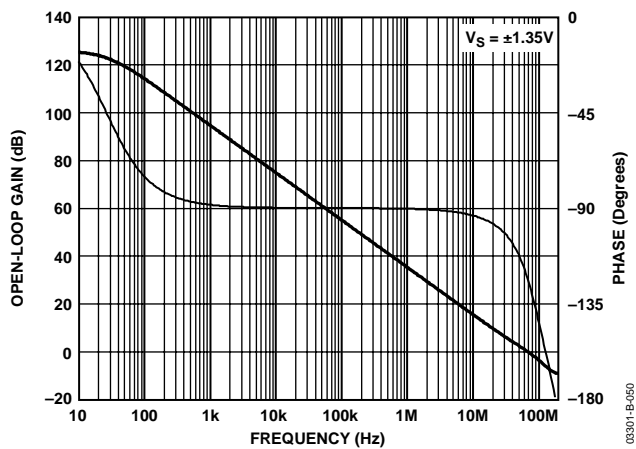

Figure 49. Open-Loop Gain and Phase vs. Frequency

03301-B-050

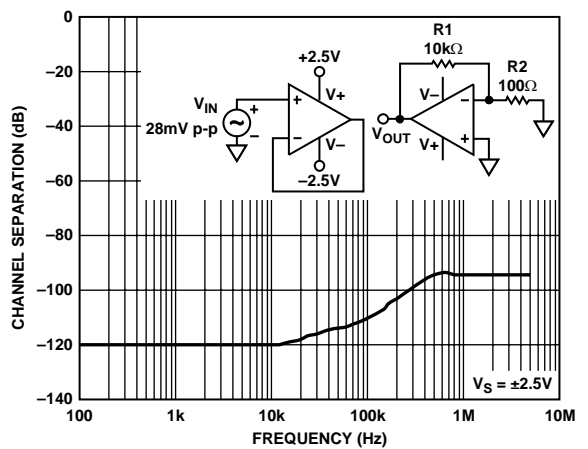

Figure 52. Channel Separation

03301-B-062

APPLICATIONS

THEORY OF OPERATION

The AD8651 amplifier is a voltage feedback, rail-to-rail input and output precision CMOS amplifier that operates from 2.7 V to 5.0 V of power supply voltage. This amplifier uses Analog Devices' DigiTrim technology to achieve a higher degree of precision than is available from most CMOS amplifiers. DigiTrim technology, used in a number of ADI amplifiers, is a method of trimming the offset voltage of the amplifier after it has been assembled. The advantage of post-package trimming is that it corrects any offset voltages caused by the mechanical stresses of assembly.

The AD8651 is available in standard op amp pinout, making DigiTrim completely transparent to the user. The input stage of the amplifier is a true rail-to-rail architecture, allowing the input common-mode voltage range of the op amp to extend to both positive and negative supply rails. The open-loop gain of the AD8651/AD8652 with a load of 1 k Ω is typically 115 dB.

The AD8651 can be used in any precision op amp application. The amplifier does not exhibit phase reversal for common-mode voltages within the power supply. With voltage noise of 4.5 nV/ $\sqrt{\text{Hz}}$ and -105 dB distortion for 10 kHz, 2 V p-p signals, the AD8651/AD8652 is a great choice for high resolution data acquisition systems. Its low noise, sub-pA input bias current, precision offset, and high speed make it a superb preamp for fast photodiode applications. The speed and output drive capability of the AD8651 also make it useful in video applications.

Rail-to-Rail Output Stage

The voltage swing of the output stage is rail-to-rail and is achieved by using an NMOS and PMOS transistor pair connected in a common source configuration. The maximum

output voltage swing is proportional to the output current, and larger currents will limit how close the output voltage can get to the proximity of the output voltage to the supply rail. This is a characteristic of all rail-to-rail output amplifiers. With 40 mA of output current, the output voltage can reach within 5 mV of the positive and negative rails. At light loads of >100 k Ω , the output swings within ~1 mV of the supplies.

Rail-to-Rail Input Stage

The input common-mode voltage range of the AD8651 extends to both positive and negative supply voltages. This maximizes the usable voltage range of the amplifier, an important feature for single-supply and low voltage applications. This rail-to-rail input range is achieved by using two input differential pairs, one NMOS and one PMOS, placed in parallel. The NMOS pair is active at the upper end of the common-mode voltage range, and the PMOS pair is active at the lower end of the common-mode range.

The NMOS and PMOS input stages are separately trimmed using DigiTrim to minimize the offset voltage in both differential pairs. Both NMOS and PMOS input differential pairs are active in a 500 mV transition region when the input common-mode voltage is approximately 1.5 V below the positive supply voltage. A special design technique improves the input offset voltage in the transition region that traditionally exhibits a slight V_{OS} variation. As a result, the common-mode rejection ratio is improved within this transition band. Compared to the Burr Brown OPA350 amplifier, shown in Figure 53 (A), the AD8651, shown in Figure 53 (B), exhibits much lower offset voltage shift across the entire input common-mode range, including the transition region.

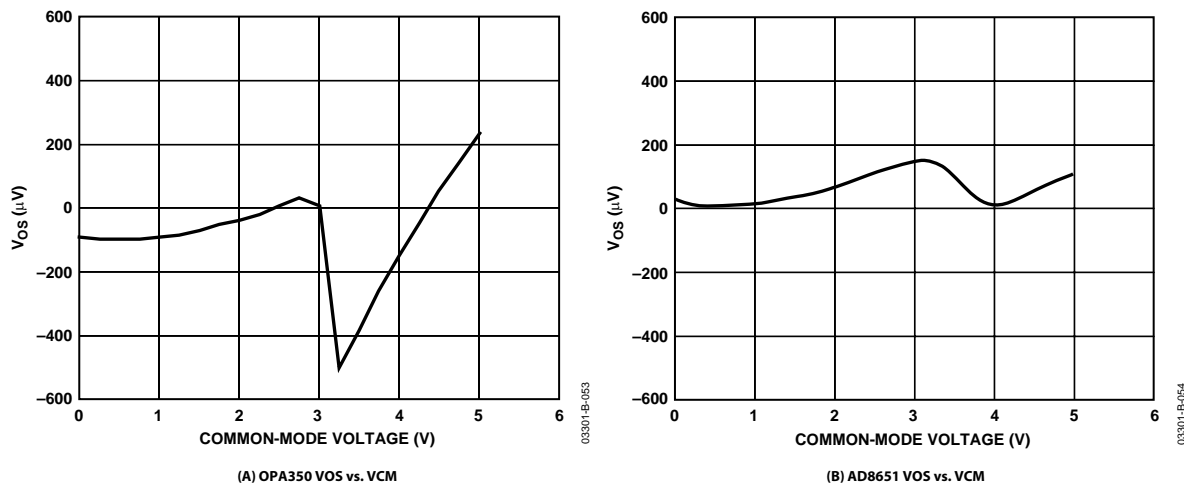

Figure 53. Input Offset Distribution over Common-Mode Voltage

Input Protection

As with any semiconductor device, if a condition could exist for the input voltage to exceed the power supply, the device's input overvoltage characteristic must be considered. The inputs of the AD8651 are protected with ESD diodes to either power supply. Excess input voltage will energize internal PN junctions in the AD8651, allowing current to flow from the input to the supplies. This results in an input stage with picoamps of input current that can withstand up to 4000 V ESD events (human body model) with no degradation.

Excessive power dissipation through the protection devices will destroy or degrade the performance of any amplifier. Differential voltages greater than 7 V will result in an input current of approximately $(|V_{CC} - V_{EE}| - 0.7 \text{ V})/R_i$, where R_i is the resistance in series with the inputs. For input voltages beyond the positive supply, the input current will be approximately $(V_i - V_{CC} - 0.7)/R_i$. For input voltages beyond the negative supply, the input current will be about $(V_i - V_{EE} + 0.7)/R_i$. If the inputs of the amplifier sustain differential voltages greater than 7 V or input voltages beyond the amplifier power supply, limit the input current to 10 mA by using an appropriately sized input resistor (R_i), as shown in Figure 54.

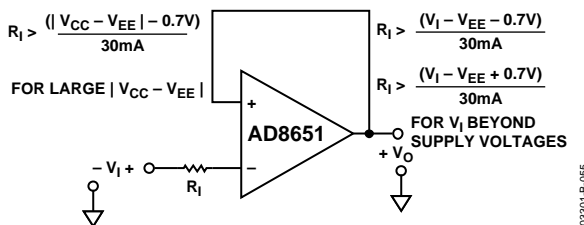

Figure 54. Input Protection Method

Overdrive Recovery

Overdrive recovery is defined as the time it takes for the output of an amplifier to come off the supply rail after an overload signal is initiated. This is usually tested by placing the amplifier in a closed-loop gain of 15 with an input square wave of 200 mV p-p while the amplifier is powered from either 5 V or 3 V. The AD8651 has excellent recovery time from overload conditions (see Figure 31 and Figure 32). The output recovers from the positive supply rail within 200 ns at all supply voltages. Recovery from the negative rail is within 100 ns at 5 V supply.

LAYOUT, GROUNDING, AND BYPASSING CONSIDERATIONS

Power Supply Bypassing

Power supply pins can act as inputs for noise, so care must be taken that a noise-free, stable dc voltage is applied. The purpose of bypass capacitors is to create low impedances from the supply to ground at all frequencies, thereby shunting or filtering most of the noise. Bypassing schemes are designed to minimize the supply impedance at all frequencies with a parallel combination of capacitors of 0.1 μF and 4.7 μF . Chip capacitors of 0.1 μF

(X7R or NPO) are critical and should be as close as possible to the amplifier package. The 4.7 μF tantalum capacitor is less critical for high frequency bypassing, and, in most cases, only one is needed per board at the supply inputs.

Grounding

A ground plane layer is important for densely packed PC boards to spread the current-minimizing parasitic inductances. However, an understanding of where the current flows in a circuit is critical to implementing effective high speed circuit design. The length of the current path is directly proportional to the magnitude of parasitic inductances and, therefore, the high frequency impedance of the path. High speed currents in an inductive ground return will create an unwanted voltage noise.

The length of the high frequency bypass capacitor leads is critical. A parasitic inductance in the bypass grounding will work against the low impedance created by the bypass capacitor. Place the ground leads of the bypass capacitors at the same physical location. Because load currents also flow from the supplies, the ground for the load impedance should be at the same physical location as the bypass capacitor grounds. For the larger value capacitors, intended to be effective at lower frequencies, the current return path distance is less critical.

Leakage Currents

Poor PC board layout, contaminants, and the board insulator material can create leakage currents that are much larger than the input bias current of the AD8651/AD8652. Any voltage differential between the inputs and nearby traces will set up leakage currents through the PC board insulator, for example, 1 V/100 G = 10 pA. Similarly, any contaminants on the board can create significant leakage (skin oils are a common problem).

To significantly reduce leakages, put a guard ring (shield) around the inputs and input leads that are driven to the same voltage potential as the inputs. This ensures that there is no voltage potential between the inputs and the surrounding area to set up any leakage currents. To be effective, the guard ring must be driven by a relatively low impedance source and should completely surround the input leads on all sides, above and below, using a multilayer board.

Another effect that can cause leakage currents is the charge absorption of the insulator material itself. Minimizing the amount of material between the input leads and the guard ring will help to reduce the absorption. Also, low absorption materials, such as Teflon® or ceramic, may be necessary in some instances.

Input Capacitance

Along with bypassing and ground, high speed amplifiers can be sensitive to parasitic capacitance between the inputs and ground. A few picofarads of capacitance will reduce the input impedance at high frequencies, which in turn increases the amplifier's gain, causing peaking in the frequency response or

AD8651/AD8652

oscillations. With the AD8651, additional input damping is required for stability with capacitive loads greater than 47 pF with direct input to output feedback (see the next section).

Output Capacitance

When using high speed amplifiers, it is important to consider the effects of the capacitive loading on the amplifier's stability. Capacitive loading interacts with the output impedance of the amplifier, causing reduction of the BW as well as peaking and ringing of the frequency response. To reduce the effects of the capacitive loading and allow higher capacitive loads, there are two commonly used methods:

1) As shown in Figure 55, place a small value resistor (R_S) in series with the output to isolate the load capacitor from the amplifier's output. Heavy capacitive loads can reduce the phase margin of an amplifier and cause the amplifier response to peak or become unstable. The AD8651 is able to drive up to 47 pF in a unity gain buffer configuration without oscillation or external compensation. However, if an application will require a higher capacitive load drive when the AD8651 is in unity gain, then the use of external isolation networks can be used. The effect produced by this resistor is to isolate the op amp output from the capacitive load. The required amount of series resistance has been tabulated in Table 5 for different capacitive load. While this technique will improve the overall capacitive load drive for the amplifier, its biggest drawback is that it reduces the output swing of the overall circuit.

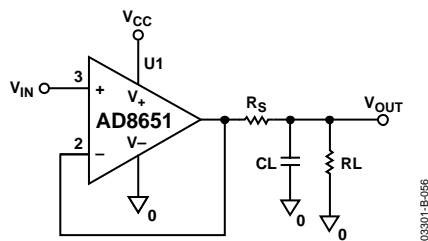

Figure 55. Driving Large Capacitive Loads

Table 5. Optimum Values for Driving Large Capacitive Loads

CL	R_S
100 pF	50 Ω
500 pF	35 Ω
1.0 nF	25 Ω

2) Another way to stabilize an op amp driving a large capacitive load is to use a snubber network, as shown in Figure 56.

Because there is not any isolation resistor in the signal path, this method has the significant advantage of not reducing the output swing. The exact values of R_S and C_S are derived experimentally. In Figure 56, an optimum R_S and C_S combination for a capacitive load drive ranging from 50 pF to 1 nF was chosen. For this, $R_S = 3 \Omega$ and $C_S = 10 \text{ nF}$ were chosen.

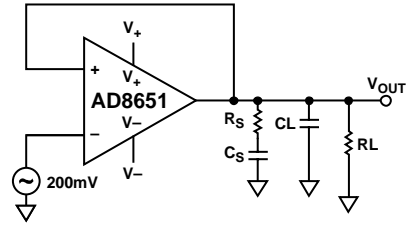

Figure 56. Snubber Network

Settling Time

The settling time of an amplifier is defined as the time it takes for the output to respond to a step change of input and enter and remain within a defined error band, as measured relative to the 50% point of the input pulse. This parameter is especially important in measurements and control circuits where amplifiers are used to buffer A/D inputs or DAC outputs. The design of the AD8651 combines a high slew rate and a wide gain bandwidth product to produce an amplifier with very fast settling time. The AD8651 is configured in the noninverting gain of 1 with a 2 V p-p step applied to its input. The AD8651 has a settling time of about 130 ns to 0.01% (2 mV). The output is monitored with a 10 \times , 10 M Ω , 11.2 pF scope probe.

THD Readings vs. Common-Mode Voltage

Total harmonic distortion of the AD8651 is well below 0.0004% with any load down to 600 Ω . The distortion is a function of the circuit configuration, the voltage applied, and the layout, in addition to other factors. The AD8651 outperforms its competitor for distortion, especially at frequencies below 20 kHz, as shown in Figure 57.

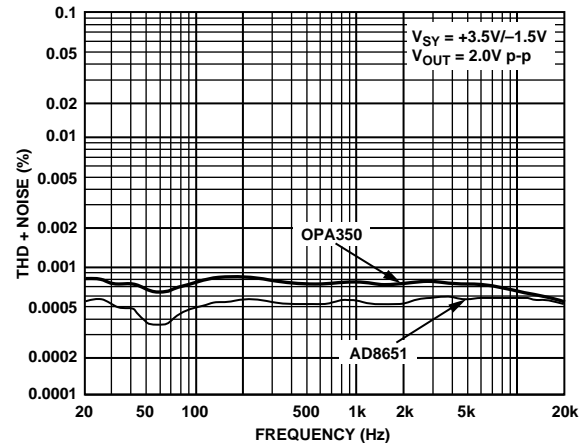

Figure 57. Total Harmonic Distortion

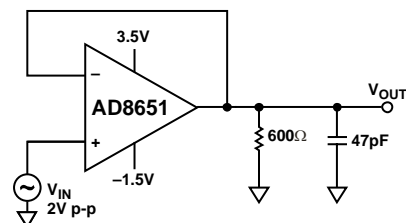

Figure 58. THD + N Test Circuit

Driving a 16-Bit ADC

The AD8651 is an excellent choice for driving high speed, high precision ADCs. The driver amplifier for this type of application needs to have low THD + N as well as quick settling time. Figure 60 shows a complete single-supply data acquisition solution. The AD8651 drives the AD7685, a 250 kSPS, 16-bit data converter.¹

The AD8651 is configured in an inverting gain of 1 with a 5 V single supply. Input of 45 kHz is applied, and the ADC samples at 250 kSPS. The results of this solution are listed in Table 6. The advantage of this circuit is that the amplifier and ADC can be powered with the same power supply. For the case of a noninverting gain of 1, the input common-mode voltage encompasses both supplies.

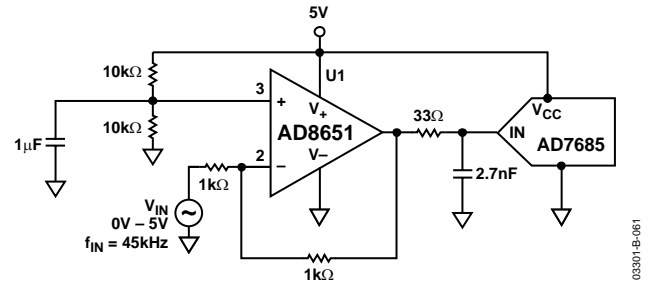

Figure 60. AD8651 Driving a 16-Bit ADC

Table 6. Data Acquisition Solution of Figure 60

Parameter	Reading (dB)
THD + N	105.2
SFDR	106.6
2 nd Harmonics	107.7
3 rd Harmonics	113.6

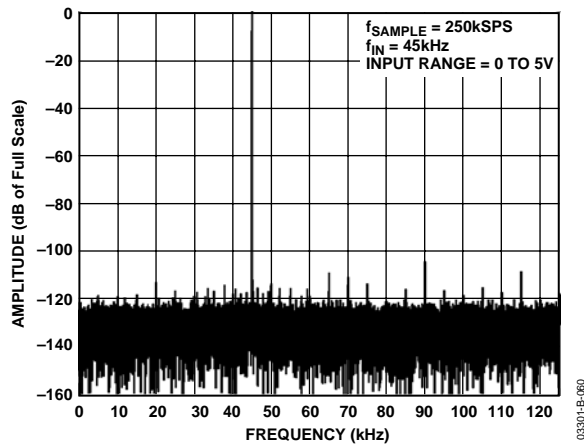

Figure 59. Frequency Response of AD8651 Driving a 16-Bit ADC

¹ For more information about the AD7685 data converter, go to http://www.analog.com/Analog_Root/productPage/productHome/0%2C21%2CAD7685%2C00.html

OUTLINE DIMENSIONS

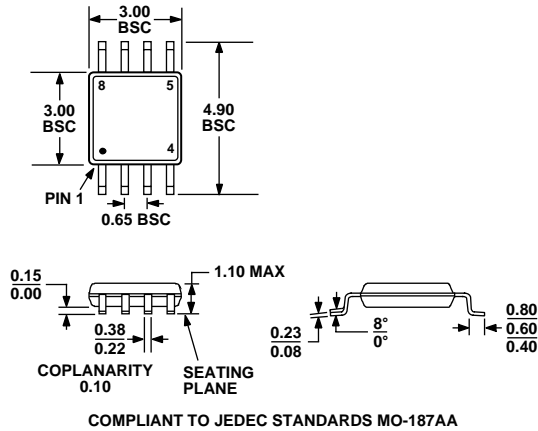

Figure 61. 8-Lead Mini Small Outline Package [MSOP]
(RM-8)
Dimensions shown in millimeters

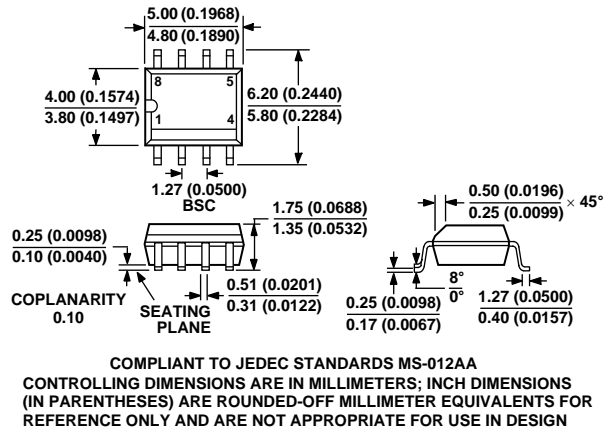

Figure 62. 8-Lead Standard Small Outline Package [SOIC]
(R-8)
Dimensions shown in millimeters and (inches)

ORDERING GUIDE

Model	Temperature Range	Package Description	Package Option	Branding
AD8651ARM-REEL	-40°C to +125°C	8-Lead MSOP	RM-8	BEA
AD8651ARM-R2	-40°C to +125°C	8-Lead MSOP	RM-8	BEA
AD8651AR	-40°C to +125°C	8-Lead SOIC	R-8	
AD8651AR-REEL	-40°C to +125°C	8-Lead SOIC	R-8	
AD8651AR-REEL7	-40°C to +125°C	8-Lead SOIC	R-8	
AD8652ARMZ-R2*	-40°C to +125°C	8-Lead MSOP	RM-8	A05
AD8652ARMZ-REEL*	-40°C to +125°C	8-Lead MSOP	RM-8	A05
AD8652ARZ*	-40°C to +125°C	8-Lead SOIC	R-8	
AD8652ARZ-REEL*	-40°C to +125°C	8-Lead SOIC	R-8	
AD8652ARZ-REEL7*	-40°C to +125°C	8-Lead SOIC	R-8	

* Z = Pb-free part.

NOTES

NOTES

